



Address:
Block 9, Shuiwei Ind Zone, Shuiwei New
Village, Dalang, Longhua, Shenzhen,
Guangdong, China 518109

Tel: (86)755-28121370/ 28121371/28109416/28109419
Fax: (86)755-28109417
E-mail: rd@horn.com.cn
Website: www.horn.com.cn

CUSTOMER: Digi-Key Corporation

APPROVAL SHEET

PRODUCT NAME	PART NUMBER	DIMENSION	REMARK
Electret Condenser Microphone	EM6022-40BC10&33	Ø6.0×2.2(mm)	D.S.PCB

APPROVED BY	CHECKED BY	ISSUED BY
		

APPROVED BY:

DATE:

PART NUMBER : EM6022-40BC10&33

Address:
Block 9, Shuiwei Ind Zone, Shuiwei New
Village, Dalang, Longhua, Shenzhen,
Guangdong, China 518109

Tel: (86)755-28121370/ 28121371/28109416/28109419
Fax: (86)755-28109417
E-mail: rd@horn.com.cn
Website: www.horn.com.cn

SPECIFICATION

Item	Symbol	Test conditions	Min	Standard	Max	Unit
Sensitivity	S	f=1KHz. P _{in} =1ubar	-42	-40	-38	dB <small>0dB=1V/Pa</small>
Directivity	Omnidirectional					
Impedance	Z _{out}				2.2	K Ω
Input sound pressure level	S.P.L				100	dB
Operation voltage	V _s	-	1.0	2	10	V
Current consumption	I	f=1KHz. P _{in} =1Pa			500	uA
Sensitivity reduction	ΔS	f=1KHz. P _{in} =1Pa. V _s =2→1.5V			-3	dB
S/N ratio	S/N(A)	f=1KHz. P _{in} =1Pa. A=curve	60			dB

Measurement Circuit (Test Condition V_s=2V R_L=2.2KΩ)

T_a=20°C R.H=65%)

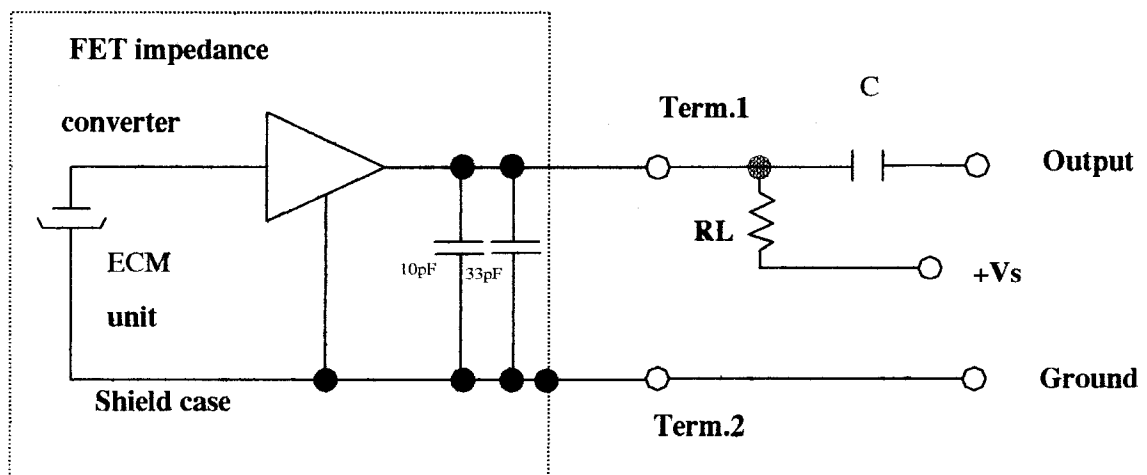

PART NUMBER : EM6022-40BC10&33

Address:
Block 9, Shuiwei Ind Zone, Shuiwei New
Village, Dalang, Longhua, Shenzhen,
Guangdong, China 518109

Tel: (86)755-28121370/ 28121371/28109416/28109419
Fax: (86)755-28109417
E-mail: rd@horn.com.cn
Website: www.horn.com.cn

Dimensional Drawing

unit: mm

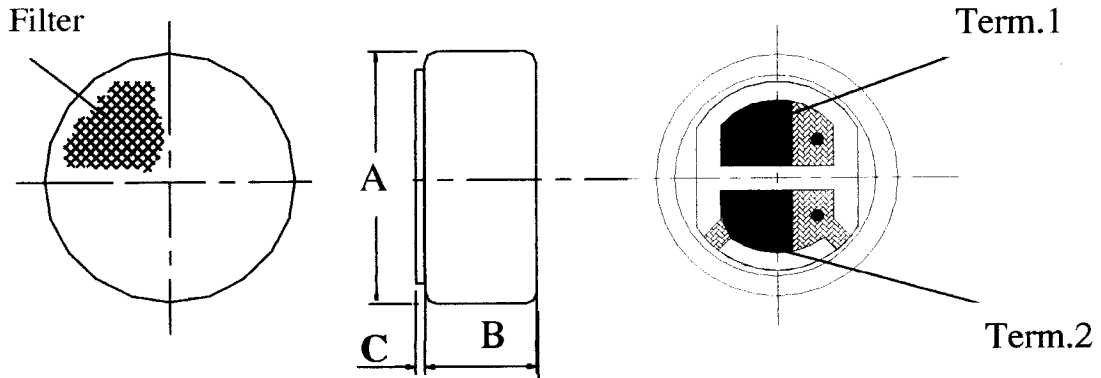

PART	MIN	STANDARD	MAX	REMARK
A	Ø5.9	Ø6.0	Ø6.1	
B	2.0	2.2	2.4	
C	0.1	0.2	0.3	

Typical Frequency Response Curve

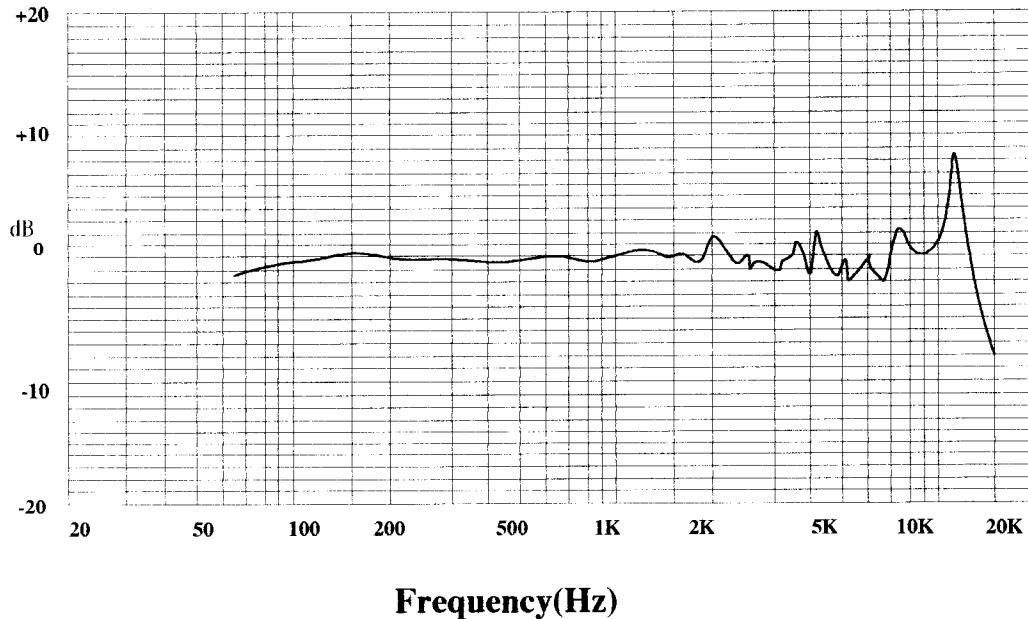

Address:
Block 9, Shuiwei Ind Zone, Shuiwei New
Village, Dalang, Longhua, Shenzhen,
Guangdong, China 518109

Tel: (86)755-28121370/ 28121371/28109416/28109419
Fax: (86)755-28109417
E-mail: rd@horn.com.cn
Website: www.horn.com.cn

Ambient condition

(1) Operating condition

Ambient temperature: $-10^{\circ}\text{C} \sim +45^{\circ}\text{C}$

Relative humidity: $\leq 85\%$

(2) Storage condition

Ambient temperature: $-20^{\circ}\text{C} \sim +60^{\circ}\text{C}$

Relative humidity: $45\% \sim 75\%$

Reliability Test

1) Vibration Test

To be no interference in operation after vibration of full amplitude 2mm for 30 minutes at three axis, the sensitivity to be within $\pm 3\text{dB}$ from initial sensitivity.

2) Drop test

To be no interference in operation after dropped to concrete floor each time from 1 meter height of three directions in state of packing, the sensitivity to be within $\pm 3\text{dB}$ from initial sensitivity.

3) High Temperature Storage:

To be no interference in operation after high temperature test $70^{\circ}\text{C} \pm 3^{\circ}\text{C}$ for 48 hours. The sensitivity to be within $\pm 3\text{dB}$ from initial sensitivity.

4) Isotherm & Iso-humidity Storage

To be no interference in operation after storage test at temperature $60^{\circ}\text{C} \pm 2^{\circ}\text{C}$ and relative humidity ($93 \pm 3\%$) for 48 hours, the sensitivity to be within $\pm 3\text{dB}$ from initial sensitivity, the test is performed at temperature 20°C after operation for 6 hours.

5) Low Temperature Storage

To be no interference in operation after test at temperature $-20^{\circ}\text{C} \pm 3^{\circ}\text{C}$ for 48 hours, the sensitivity to be within $\pm 3\text{dB}$ from initial sensitivity.

6) Temperature Cycle Test

After exposure at $55 \pm 2^{\circ}\text{C}$ for 1 hour, at $20 \pm 2^{\circ}\text{C}$ for 1 hour, at $-10 \pm 2^{\circ}\text{C}$ for 1 hour, at $20 \pm 2^{\circ}\text{C}$ for 1 hour, with 5 cycles. Change of sensitivity within $\pm 3\text{dB}$ from initial measuring should be done after 2 hours exposed to $20^{\circ}\text{C} \pm 2^{\circ}\text{C}$.

7) Collision Test

After collided with the acceleration $100 \pm 10\text{m/s}$, at the vertical & horizontal directions for 1000 ± 10 times. at the state of packing. Change of sensitivity within $\pm 3\text{dB}$ from initial.



Electret Condenser Microphone Units

深圳市豪恩电声科技有限公司
SHENZHEN HORN ELECTROACOUSTIC TECHNOLOGY CO.,LTD

TEST RESULT OF SAMPLES

NO.	1KHz (dB)	CURRENT (mA)	NOTES
1	-39.6	0.18	(1KHz、0dB=1V/Pa)
2	-40.5	0.18	
3	-40.4	0.17	
4	-39.8	0.14	
5	-39.9	0.17	
6	-39.7	0.18	
7	-40.7	0.18	
8	-40.7	0.18	
9	-40.4	0.18	
10	-39.5	0.17	
11	-40.5	0.17	
12	-40.7	0.19	
13	-39.5	0.17	
14	-40.5	0.17	
15	-40.4	0.19	

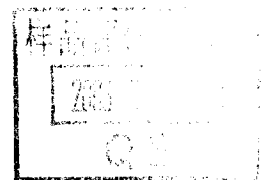

Customer: Digi-Key Corporation

Date: 2003.12.09

Part number: EM6022-40BC10&33

Sensitivity: -40±2dB

Test condition: 2.2K Ω 2V

Tester: G1

SHENZHEN HORN ELECTROACOUSTIC TECHNOLOGY CO., LTD.
X:1.0000kHz *Y:-40.87dB* ZA:Live Curve SSR Fund.

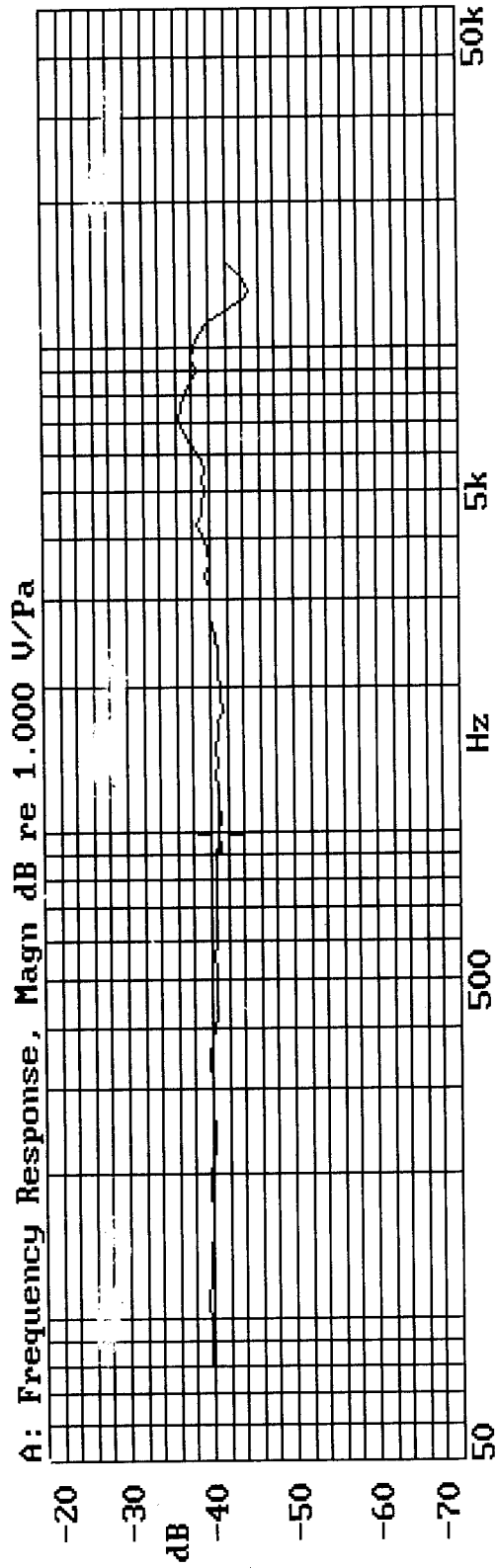

MODEL: EM6022-40BC10&33

CODE: 8#

SENSITIVITY: -40.87dB (1KHz)

TEST CONDITION: 2.2KΩ 2V

08-DEC-2003 16:01:53

Mode: SSR





Electret Condenser Microphone Units

深圳市豪恩电声科技有限公司

SHENZHEN HORN ELECTROACOUSTIC TECHNOLOGY CO., LTD

TEL: 86-755-28121370/28121371/28109416/28109419

FAX: 86-755-28109417

Website: www.horn.com.cn

E-mail: rd@horn.com.cn

Certificate of Confirmed Products

Date: Dec. 07. 2003

NO: W031206002

SUPPLIER	HORN	BUYER	Digi-Key Corporation	
TITLE	ECM	MODEL	EM6022-40BC10&33	
SIZE	$\phi 6.0 \times 2.2\text{mm}$	TEST CONDITION	2.2K Ω 2V	
QUANTITY		SAMPLE: 15PCS		
SPECIFICATIONS				
Sensitivity		-40 \pm 2dB (0dB=1V/Pa. 1KHz)		
Directivity		Omnidirectional		
Impedance		Low impedance		
Standard operation voltage		2V		
Operation voltage		1.0-10V		
Current consumption		Max 500uA		
Maximum input S.P.L		100dB		
S/N ratio		More than 60 dB		
Sensitive reduction		within-3dB at 1.5V		
The test result from customers		Signature: _____ . _____ . 2003		
Final confirmed	Pass	Refuse	Accepted basis on	
Remarks				

***** The form must be confirmed by return fax after your test as your best regards! *****